



## PRODUCT FEATURES

- Easy "Horizontal" Slide Connection System
- Vertical Slide-Up Replacement System
- Slim Design for Long Seamless Runs
- 1-10V Integrated Dimming

## PRODUCT SPECIFICATIONS

- Voltage: AC 100-277V
- Operating Temperature: 0-40°C
- Power Factor : PF>0.9
- Lamp Life: 40,000hr / 70%
- Available Color: \*2200K, 2700K, 3000K, 3500K, 4000K
- CRI > 90
- Max Connection per Single Power Feed
  - Dimming : 20pcs Max
  - Non-Dimming : 400W
  - 5W(80pcs), 10W(40pcs), 15W(26pcs), 20W(20pcs)



\* 4000K performance data shown. Refer to individual luminaire IES files for other CCTs.

\* Pending factory availability

Product	Model Number	Voltage Input	Energy Consumption	Luminous Flux	Luminous Efficacy	Color Rendering Index	Operating Temperature
VSSL	VSSL5 40K-UNV-C90	AC 100~277V	4.9W	410.4 lm	82lm/W	CRI > 90	0-40°C
	VSSL10 40K-UNV-C90	AC 100~277V	9.8W	730.3 lm	74.15lm/W	CRI > 90	0-40°C
	VSSL15 40K-UNV-C90	AC 100~277V	14.8W	1,208.3 lm	81.52lm/W	CRI > 90	0-40°C
	VSSL20 40K-UNV-C90	AC 100~277V	20.3W	1,697.4 lm	83.51lm/W	CRI > 90	0-40°C

## MODEL SELECTION KEY

VSSL - 20 - 40K - UNV - C90 -

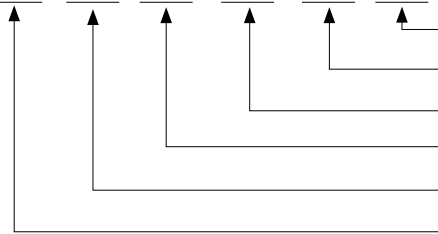

- (Blank) Standard Round Lens (SQ) Square Lens Optional
- Color Rendering - CRI>90
- Universal voltage (VSSL: 100~277V)
- Kelvin temperature (ex: 3000K - 30K)
- Lamp power
- Series name (VSSL: 1-10V dimming)



Square Lens Optional

\*(Blank) Standard Round Lens

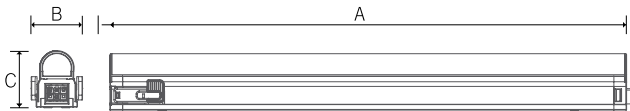

\*(SQ) Square Lens Optional

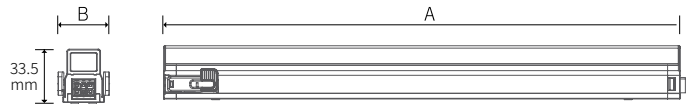

Product	Model Number	Dimension		
		A	B	C
VSSL	VSSL5 (color)K-UNV-C90	290mm	32.3mm	35.2mm
	VSSL10 (color)K-UNV-C90	580mm	32.3mm	35.2mm
	VSSL15 (color)K-UNV-C90	870mm	32.3mm	35.2mm
	VSSL20 (color)K-UNV-C90	1160mm	32.3mm	35.2mm

## DIMENSION

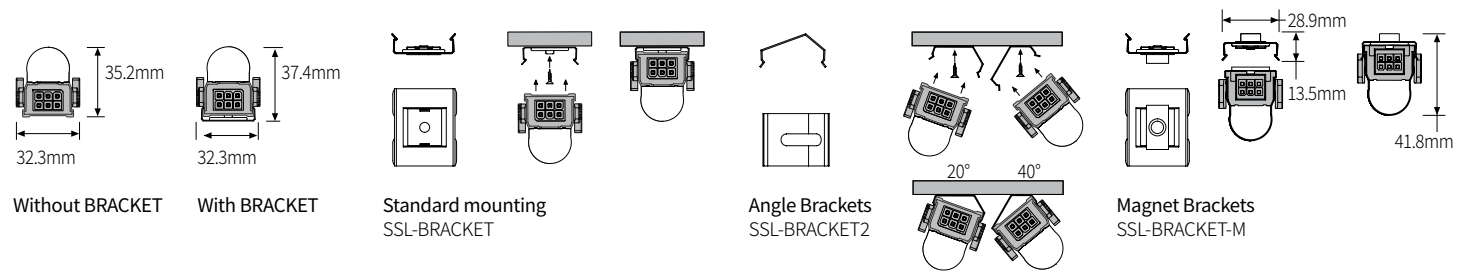

## SLIDE CONNECTION SYSTEM

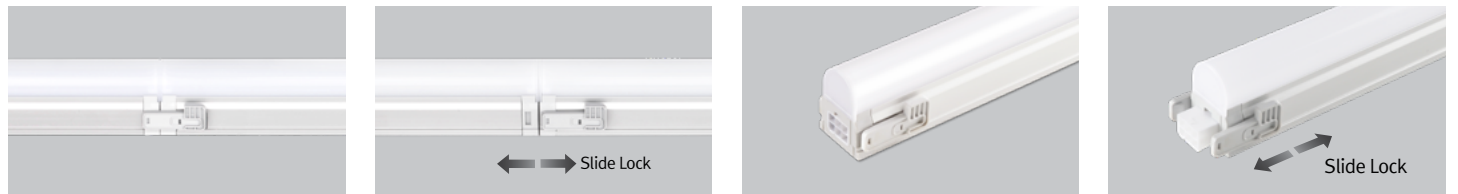

## INSTALLATION

- VSSL

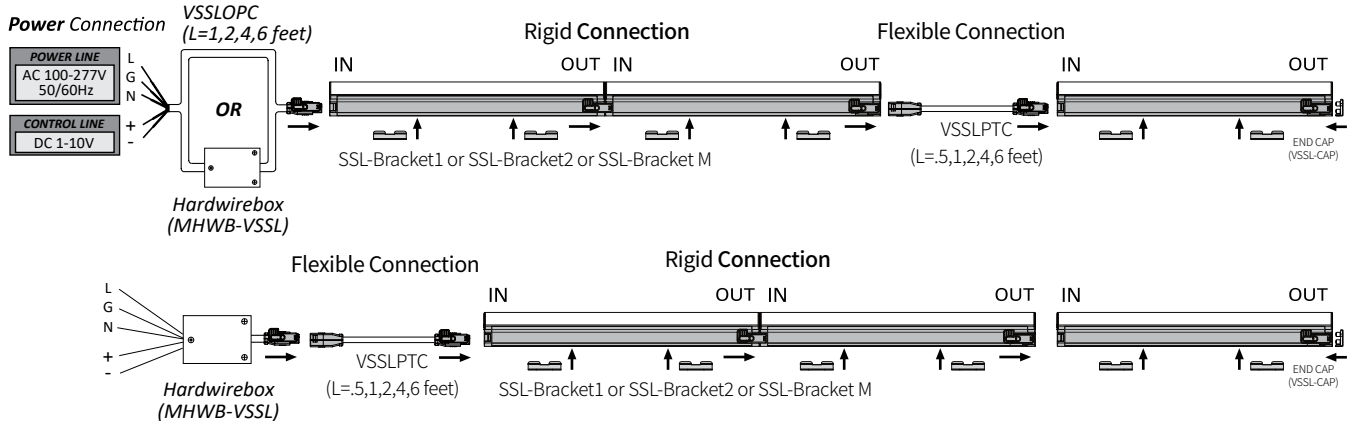

★ Wire Diagram

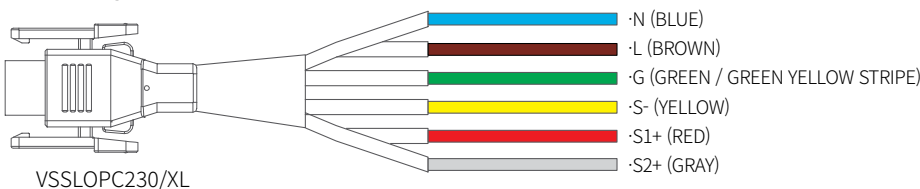

## BEAM SPREADS

VSSL5 40K-24V  
82 lm/W  
410.4 lm

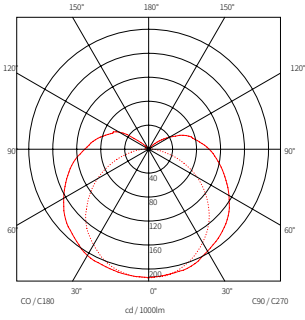

VSSL10 40K-24V  
74.15 lm/W  
730.3 lm

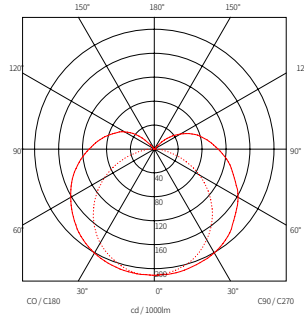

VSSL15 40K-24V  
81.52 lm/W  
1,208.3 lm

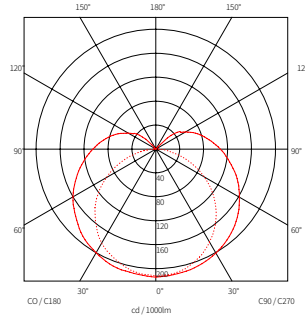

VSSL20 40K-24V  
83.51 lm/W  
1697.4 lm

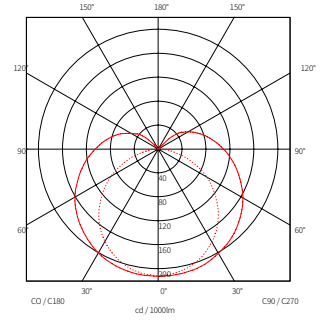

4000K performance data shown. Refer to individual luminaire IES files for other CCTs.

## ACCESSORIES

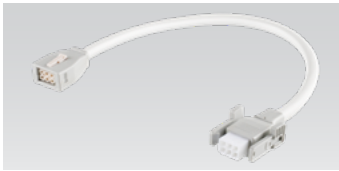

### Connecting Cable

- \_\_VSSLPTC/T (150mm)
- \_\_VSSLPTC1/T (300mm)
- \_\_VSSLPTC2/T (600mm)
- \_\_VSSLPTC4/T (1,200mm)
- \_\_VSSLPTC6/T (1,800mm)



### Open Power Cord

- \_\_VSSLOPC230/T (150mm)
- \_\_VSSLOPC1/T (300mm)
- \_\_VSSLOPC2/T (600mm)
- \_\_VSSLOPC4/T (1,200mm)



### Mounting Brackets (Included fixture)

- \_\_SSL-BRACKET(B) : 1set = 3pcs



### Angle Brackets (Optional)

- \_\_SSL-BRACKET2(B) : 1set = 3pcs



### Magnet Brackets (Optional)

- \_\_SSL-BRACKET-M(B) : 1set = 3pcs